

HUFNAGEL
▶▶▶ die spanbrecher

SONDERAKTION **GÜLTIG BIS**
2019 **31.12.2019**

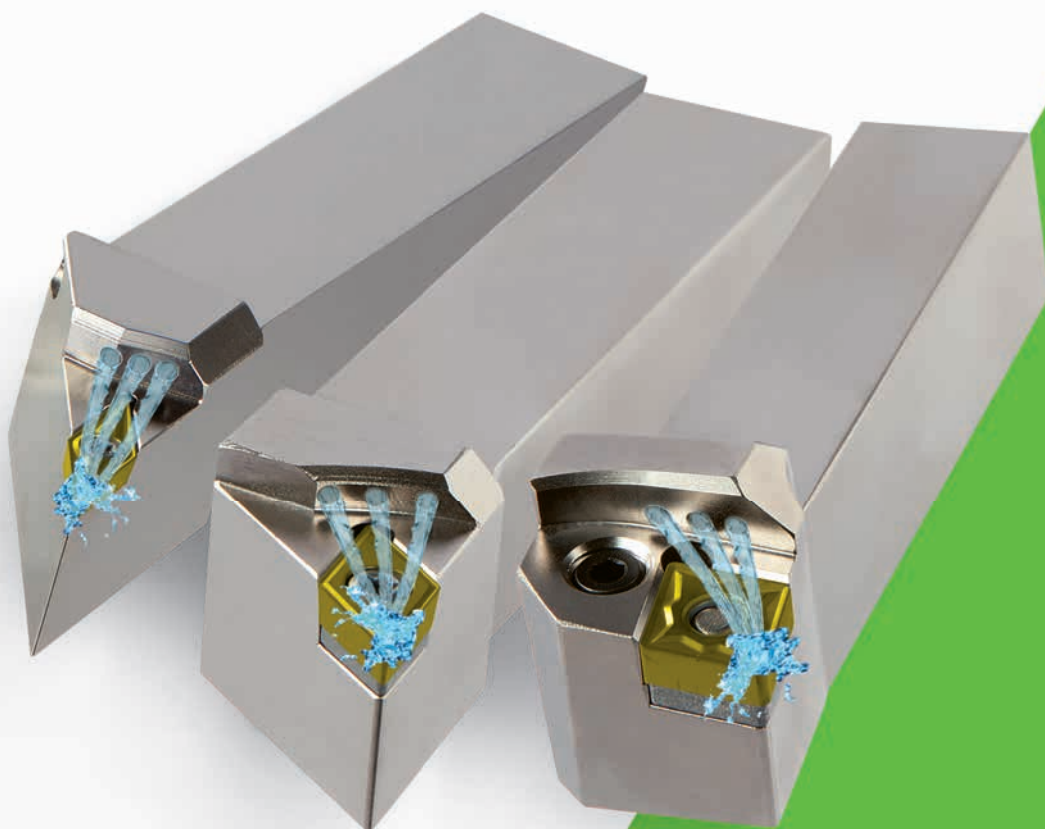

PRODUKTIVITÄT / WIRTSCHAFTLICHKEIT / INNOVATION / PRÄZISION / LÖSUNGEN / ZUVERLÄSSIGKEIT
VEREINT IN EINEM PROFESSIONELLEN UND LEISTUNGSSTARKEN TEAM. WIR HELFEN GERNE WEITER!

APKT 060204 FRÄSER-SÄTZE

SET 741C W

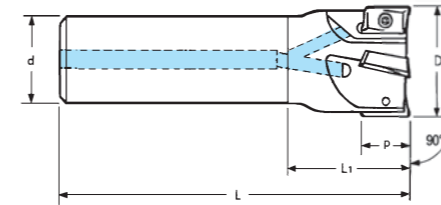

PROFIBOX

Träger + Platten

20 Wendeplatten und der passende Schaftfräser jetzt in der neuen PROFIBOX!

SET 741C W D10

Aktionspreis € 179,- NET/SET	1PC 20PCS	741C W D10/2 APKT 060204 PDTR-K K400
---	--------------	---

SET 741C W D12

Aktionspreis € 189,- NET/SET	1PC 20PCS	741C W D12/3 APKT 060204 PDTR-K K400
---	--------------	---

SET 741C W D16

Aktionspreis € 219,- NET/SET	1PC 20PCS	741C W D16/4 APKT 060204 PDTR-K K400
---	--------------	---

SET 741M W

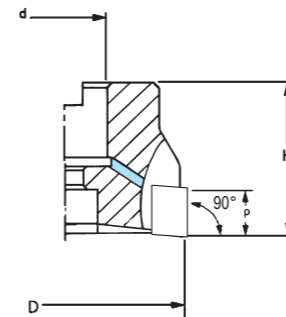

PROFIBOX

Träger + Platten

20 Wendeplatten und der passende Eckfräser jetzt in der neuen PROFIBOX!

SET 741M W D32

Aktionspreis € 259,- NET/SET	1PC 20PCS	741M W D32/8 APKT 060204 PDTR-K K400
---	--------------	---

SET 741M W D40

Aktionspreis € 279,- NET/SET	1PC 20PCS	741M W D40/10 APKT 060204 PDTR-K K400
---	--------------	--

SET 741M W D50

Aktionspreis € 299,- NET/SET	1PC 20PCS	741M W D50/11 APKT 060204 PDTR-K K400
---	--------------	--

Bestell-Nr.	D	d	L	L ₁	p	z
741C W D10/2	10	10	100	28	5,2	2
741C W D12/3	12	12	100	30	5,2	3
741C W D14/3	14	12	120	32	5,2	3
741C W D16/4	16	16	120	32	5,2	4
741C W D18/4	18	16	120	32	5,2	4
741C W D20/5	20	20	150	35	5,2	5
741C W D25/7	25	20	150	35	5,2	7
741C W D32/8	32	25	150	35	5,2	8

Bestell-Nr.	D	d	H	p	z
741M W D32/8	32	16	40	5,2	8
741M W D40/10	40	16	40	5,2	10
741M W D50/11	50	22	40	5,2	11

APKT 1003 FRÄSER-SÄTZE

SET 740W W

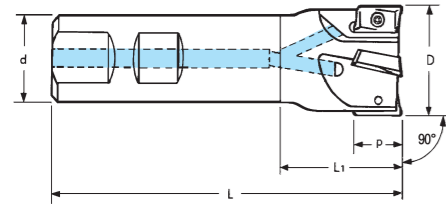

PROFI-BOX

Träger +
Platten

20 Wendepplatten und
der passende Schaftfräser
jetzt in der neuen PROFIBOX!

Bestell-Nr.	D	d	L	L ₁	p	z
740W W D10/1	10	16	80	24	10	1
740W W D11/1	11	16	80	24	10	1
740W W D12/1	12	16	80	24	10	1
740W W D13/1	13	16	80	24	10	1
740W W D14/1	14	16	80	24	10	1
740W W D15/2	15	16	85	25	10	2
740W W D15,7/2	15,7	16	85	25	10	2
740W W D16/2	16	16	85	25	10	2
740W W D17/2	17	16	85	25	10	2
740W W D18/2	18	20	85	25	10	2
740W W D19,5/3	19,5	20	90	25	10	3
740W W D19,7/3	19,7	20	90	25	10	3
740W W D20/3	20	20	90	25	10	3
740W W D22/3	22	25	95	25	10	3
740W W D24,7/4	24,7	25	95	25	10	4
740W W D25/4	25	25	95	25	10	4
740W W D32/5	32	25	95	31	10	5

SET 740W W D16

Aktionspreis
€ 159,-
NET/SET

1PC 740W W D16/2
20PCS APKT 1003 PDER-S K300

SET 740W W D20

Aktionspreis
€ 169,-
NET/SET

1PC 740W W D20/3
20PCS APKT 1003 PDER-S K300

SET 740W W D25

Aktionspreis
€ 189,-
NET/SET

1PC 740W W D25/4
20PCS APKT 1003 PDER-S K300

SET 740M W

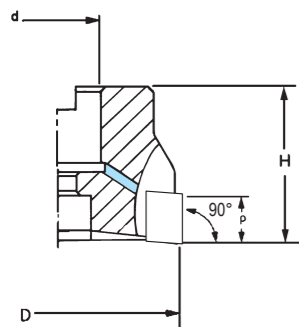

PROFI-BOX

Träger +
Platten

20 Wendepplatten und
der passende Eckfräser
jetzt in der neuen PROFIBOX!

Bestell-Nr.	D	d	H	p	z
740M W D40/6	40	16	40	10	6
740M W D50/7	50	22	40	10	7
740M W D63/8	63	22	40	10	8
740M W D80/11	80	27	50	10	11
740M W D100/12	100	32	50	10	12

SET 740M W D40

Aktionspreis
€ 249,-
NET/SET

1PC 740M W D40/6
20PCS APKT 1003 PDER-S K300

SET 740M W D50

Aktionspreis
€ 259,-
NET/SET

1PC 740M W D50/7
20PCS APKT 1003 PDER-S K300

SET 740M W D63

Aktionspreis
€ 269,-
NET/SET

1PC 740M W D63/8
20PCS APKT 1003 PDER-S K300

APKT 1604 FRÄSER-SÄTZE

SET 730W W D25

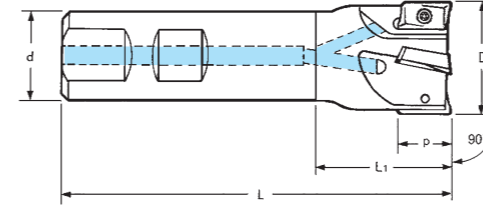

PROFI-BOX

Träger +
Platten

20 Wendepplatten und
der passende Schaftfräser
jetzt in der neuen PROFIBOX!

Bestell-Nr.	D	d	L	L ₁	p	z
730W W D25/2	25	25	100	44	17	2
730W W D32/3	32	32	110	50	17	3
730W W D40/4	40	32	115	45	17	4
730W WL D22/2	22	20	200	145	17	2
730W WL D25/2	25	25	200	140	17	2
730W WL D32/3	32	32	200	140	17	3
730W WL D40/4	40	32	200	60	17	4

SET 730W W D25

Aktionspreis
€ 189,-
NET/SET

1PC 730W W D25/2
20PCS APKT 1604 PDER-S K300

SET 730M W

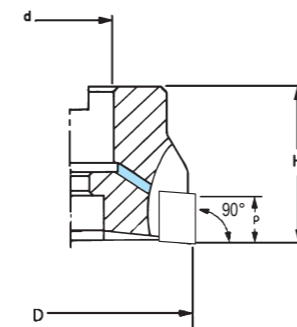

PROFI-BOX

Träger +
Platten

20 Wendepplatten und
der passende Eckfräser
jetzt in der neuen PROFIBOX!

Bestell-Nr.	D	d	H	p	z
730M W D40/4	40	16	40	17	4
730M W D50/5	50	22	40	17	5
730M W D63/6	63	22	40	17	6
730M W D80/7	80	27	50	17	7
730M W D100/8	100	32	50	17	8
730M W D125/9	125	40	63	17	9
730M D160/10	160	40	63	17	10
730M D200/13	200	60	63	17	13
730M D250/16	250	60	63	17	16

SET 730M W D40

Aktionspreis
€ 239,-
NET/SET

1PC 730M W D40/4
20PCS APKT 1604 PDER-S K300

SET 730M W D50

Aktionspreis
€ 249,-
NET/SET

1PC 730M W D50/5
20PCS APKT 1604 PDER-S K300

SET 730M W D63

Aktionspreis
€ 259,-
NET/SET

1PC 730M W D63/6
20PCS APKT 1604 PDER-S K300

LNMX 1006 FRÄSER-SÄTZE

SET 745W W

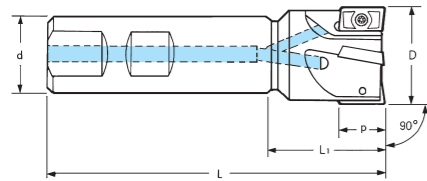

PROFIBOX Träger + Platten

20 Wendeplatten und
der passende Schaftfräser
jetzt in der neuen PROFIBOX!

SET 745W W D20

Aktionspreis	1PC	745W W D20/3
€ 199,-	10PCS	LNMX 100605 PNR-MB P200
NET/SET	10PCS	LNMX 100605 PNR-MB K300

SET 745W W D25

Aktionspreis	1PC	745W W D25/3
€ 219,-	10PCS	LNMX 100605 PNR-MB P200
NET/SET	10PCS	LNMX 100605 PNR-MB K300

Bestell-Nr.	D	d	L	L ₁	p	z
745W W D20/3	20	20	100	30	9	3
745W W D25/3	25	25	115	35	9	3
745W W D32/4	32	25	125	40	9	4
745W WL D20/3	20	20	150	50	9	3
745W WL D25/3	25	25	150	50	9	3
745W WL D32/4	32	32	200	60	9	4

SET 745M W

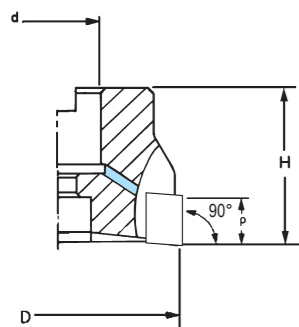

PROFIBOX Träger + Platten

20 Wendeplatten und
der passende Eckfräser
jetzt in der neuen PROFIBOX!

SET 745M W D40

Aktionspreis	1PC	745M W D40/5
€ 299,-	10PCS	LNMX 100605 PNR-MB P200
NET/SET	10PCS	LNMX 100605 PNR-MB K300

SET 745M W D50

Aktionspreis	1PC	745M W D50/7
€ 309,-	10PCS	LNMX 100605 PNR-MB P200
NET/SET	10PCS	LNMX 100605 PNR-MB K300

Bestell-Nr.	D	d	H	p	z
745M W D40/5	40	16	40	9	5
745M W D50/7	50	22	40	9	7
745M W D63/9	63	22	40	9	9

SET 745M W D63

Aktionspreis	1PC	745M W D63/9
€ 319,-	10PCS	LNMX 100605 PNR-MB P200
NET/SET	10PCS	LNMX 100605 PNR-MB K300

WNEU 0403 FRÄSER-SÄTZE

SET 830M

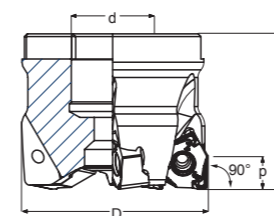

PROFIBOX Träger + Platten

20 Wendeplatten und
der passende Eckfräser
jetzt in der neuen PROFIBOX!

SET 830M W D32

Aktionspreis	1PC	830M W D32/6
€ 319,-	20PCS	WNEU 040308-MM K300
NET/SET		

SET 830M W D40

Aktionspreis	1PC	830M W D40/6
€ 339,-	20PCS	WNEU 040308-MM K300
NET/SET		

Bestell-Nr.	D	d	H	p	z
830M W D32/6	32	16	40	4	6
830M W D40/6	40	16	40	4	6
830M W D50/8	50	22	40	4	8
830M W D63/9	63	22	40	4	9

SET 830M W D50

Aktionspreis	1PC	830M W D50/8
€ 349,-	20PCS	WNEU 040308-MM K300
NET/SET		

WNEU 0806 FRÄSER-SÄTZE

SET 835M W

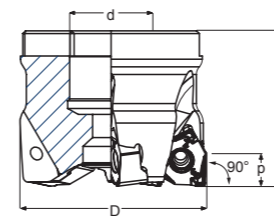

PROFIBOX Träger + Platten

20 Wendeplatten und
der passende Eckfräser
jetzt in der neuen PROFIBOX!

SET 835M W D50

Aktionspreis	1PC	835M W D50/5
€ 389,-	10PCS	WNEU 080608-MB P200
NET/SET	10PCS	WNEU 080608-MB P300

SET 835M W D63

Aktionspreis	1PC	835M W D63/6
€ 399,-	10PCS	WNEU 080608-MB P200
NET/SET	10PCS	WNEU 080608-MB P300

Bestell-Nr.	D	d	H	p	z
835M W D50/5	50	22	40	7	5
835M W D63/6	63	22	40	7	6
835M W D80/7	80	27	50	7	7
835M W D100/8	100	32	50	7	8
835M W D125/10	125	40	63	7	10
835M W D160/11	160	40	63	7	11

SET 835M W D80

Aktionspreis	1PC	835M W D80/7
€ 419,-	10PCS	WNEU 080608-MB P200
NET/SET	10PCS	WNEU 080608-MB P300

SNMX-SNMU - ONMU PLANFRÄSER-SÄTZE

SET 810M W SN

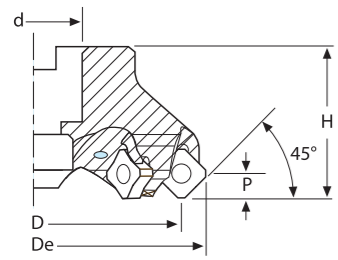

PROFIBOX Träger + Platten

20 Wendepplatten und der passende Planfräser jetzt in der neuen PROFIBOX!

SET 810M W D50 SN

Aktionspreis € 279,-
NET/SET 1PC 810M W D50/4
10PCS SNMX 1206 ANN-MB1 K300
10PCS SNMU 1206 ANER P200

SET 810M W D63 SN

Aktionspreis € 299,-
NET/SET 1PC 810M W D63/6
10PCS SNMX 1206 ANN-MB1 K300
10PCS SNMU 1206 ANER P200

SET 810M W D80 SN

Aktionspreis € 329,-
NET/SET 1PC 810M W D80/7
10PCS SNMX 1206 ANN-MB1 K300
10PCS SNMU 1206 ANER P200

Bestell-Nr.	D	De	d	H	p	z
810M W D50/4	50	63	22	40	6	4
810M W D63/6	63	76	22	40	6	6
810M W D80/7	80	93	27	50	6	7
810M W D100/8	100	113	32	50	6	8
810M W D125/10	125	138	40	63	6	10
810M W D160/12	160	173	40	63	6	12
810M W D200/14	200	213	60	63	6	14
810M W D250/16	250	263	60	63	6	16

SET 810M W SN-ON

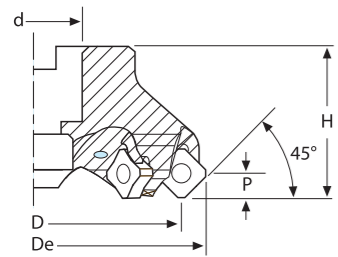

PROFIBOX Träger + Platten

20 Wendepplatten und der passende Planfräser jetzt in der neuen PROFIBOX!

SET 810M W D50 SN-on

Aktionspreis € 279,-
NET/SET 1PC 810M W D50/4
10PCS SNMU 1206 ANER K300
10PCS ONMU 1205 ANN-MB K300

SET 810M W D63 SN-on

Aktionspreis € 299,-
NET/SET 1PC 810M W D63/6
10PCS SNMU 1206 ANER K300
10PCS ONMU 1205 ANN-MB K300

SET 810M W D80 SN-on

Aktionspreis € 329,-
NET/SET 1PC 810M W D80/7
10PCS SNMU 1206 ANER K300
10PCS ONMU 1205 ANN-MB K300

Bestell-Nr.	D	De	d	H	p	z
810M W D50/4	50	63	22	40	6	4
810M W D63/6	63	76	22	40	6	6
810M W D80/7	80	93	27	50	6	7
810M W D100/8	100	113	32	50	6	8
810M W D125/10	125	138	40	63	6	10
810M W D160/12	160	173	40	63	6	12
810M W D200/14	200	213	60	63	6	14
810M W D250/16	250	263	60	63	6	16

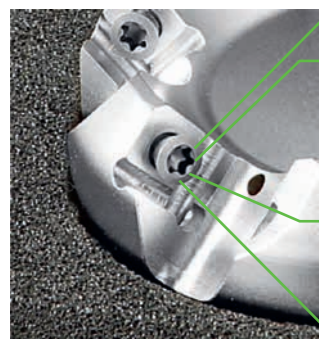

AUF SELBEM PLATTENSITZ, KÖNNEN SIE 2 WENDEPLATTEN TYPOLOGIE MONTIEREN: 8 SCHNEIDEN UND 16 SCHNEIDEN

ECO FRÄSER + ECO SATZ

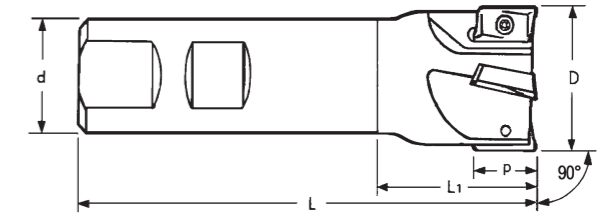

NEU ART. 740W ECO



Bestell-Nr.	Abmessungen (mm.)							APHT APHX APKT 1003...	VT25	BT08	kg	Aktionspreis NET/PC
	D	d	L	L ₁	p	β	z					
740W D16/2 ECO	16	16	85	34	10	3,5°	2				0,130	€ 49,-
740W D20/3 ECO	20	20	90	37	10	1,5°	3				0,200	€ 59,-
740W D25/4 ECO	25	25	95	46	10	0,9°	4				0,340	€ 69,-

NEU ART. 740M ECO

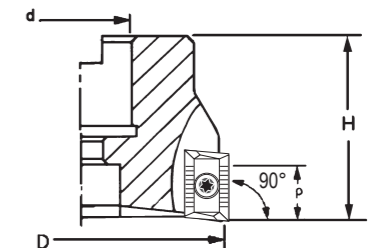

Bestell-Nr.	Abmessungen (mm.)						APHT APHX APKT 1003...	VT25	BT08	kg	Aktionspreis NET/PC
	D	d	H	p	β	z					
740M D40/6 ECO	40	16	40	10	-	6				0,270	€ 109,-
740M D50/7 ECO	50	22	40	10	-	7				0,430	€ 119,-

NEU SET 740W ECO



PROFIBOX Träger + Platten

20 Wendepplatten und der passende Schaftfräser jetzt in der neuen PROFIBOX!

SET 740W D16 ECO

Aktionspreis € 129,-
NET/SET 1PC 740W D16/2 ECO
20PCS APKT 1003 PDR-M K400

SET 740W D20 ECO

Aktionspreis € 149,-
NET/SET 1PC 740W D20/3 ECO
20PCS APKT 1003 PDR-M K400

SET 740W D25 ECO

Aktionspreis € 159,-
NET/SET 1PC 740W D25/4 ECO
20PCS APKT 1003 PDR-M K400

TCMX FASEN-ZENTRIERFRÄSER-SÄTZE

SET 311W W

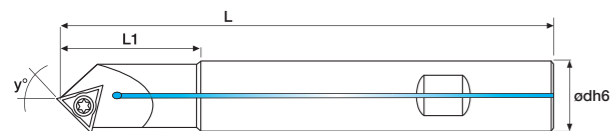

PROFIBOX
Träger +
Platten

4 Wendepalten und der
passende Fas- und Zentrierfräser
jetzt in der neuen PROFIBOX!

Bestell-Nr.	Ø dh6	L	L1	Y°	Z	D _{min}	D _{max}
311.020 WW	20	115	40	45°	1	0,4	20
311.020 WWL	20	150	60	45°	1	0,4	20
311.020 WWXL	20	200	80	45°	1	0,4	20

SET 311W W

Aktionspreis
€ 149,-
NET/SET

1PC 311.020WW
4PCS TCMX 16T3ZR TIN

TCMT FASENFRÄSER-SÄTZE

SET 300W W
SET 310W W

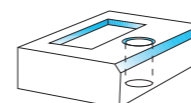
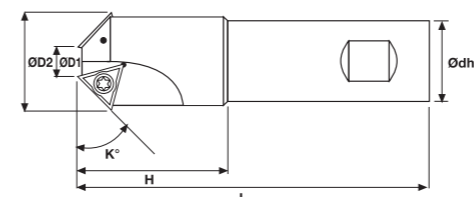

PROFI-BOX
Träger +
Platten

2 Fasenfräser für TCMT 1102 ...
jetzt in der neuen PROFIBOX!



Bestell-Nr.	ØD1	ØD2	L	H	Ødh6	Y°	Z
300.016 WW	1,2	16	70	20	12	45°	1
300.021 WW	6,2	21	90	35	20	45°	2
300.032 WW	10,4	32,5	100	42	25	45°	2

Bestell-Nr.	ØD1	ØD2	L	H	Ødh6	Y°	Z
310.016 WW	5,4	16	70	20	12	60°	1
310.027 WW	15,8	26	90	35	20	60°	2
310.032 WW	20	35	100	39	25	60°	2

SET 300W W - 45° tcm 1102...

Aktionspreis
€ 149,-
NET/SET

1PC 300.016W
1PC 300.021W

SET 310W W - 60° tcm 1102...

Aktionspreis
€ 149,-
NET/SET

1PC 310.016W
1PC 310.027W

NEU SEEX FASEN-ZENTRIERFRÄSER-SÄTZE

SET 160 W

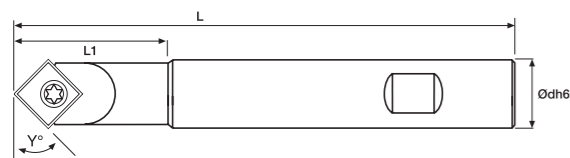

PROFIBOX
Träger +
Platten

5 Wendepalten und der
passende Fas- und Zentrierfräser
jetzt in der neuen PROFIBOX!

Bestell-Nr.	Ø dh6	DS	L	L1	Y°	Z	D _{min}	D _{max}
160.45 W	16	0,8	120	40	45°	1	0,8	17
160.30 W	16	0,8	120	40	30°	1	0,8	21

SET 160 W 45°

Aktionspreis
€ 149,-
NET/SET

1PC 160.45 W
5PCS SEEX 12T408 TIN

TCGX FASENFRÄSER-SATZ

SET 7745

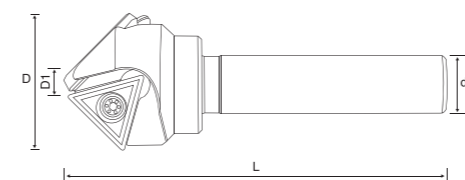

PROFIBOX
Träger +
Platten

1 Fasenfräser für TCGX ...
jetzt in der neuen PROFIBOX!

Bestell-Nr.	D	D1	L	dh6	Y°	Z
7745VT16-C12-0525	25	5	78	12	45°	1
7745VT16-C12-2545	45	25	78	12	45°	1

SET 7745

Aktionspreis
€ 149,-
NET/SET

1PC 7745VT16-C12-0525
4PCS TCGX 163504 K400

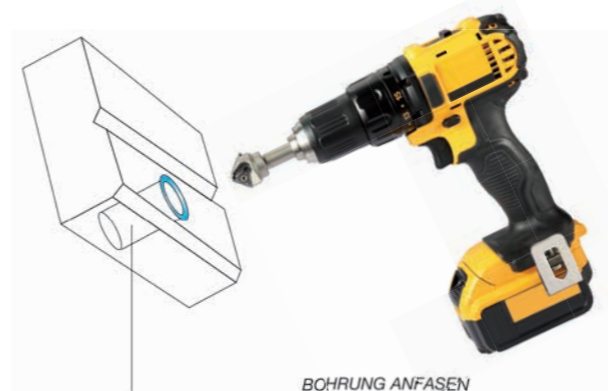

**FASENFRÄSER
NUTZBAR AUCH FÜR
HANDWERKZEUGE!**

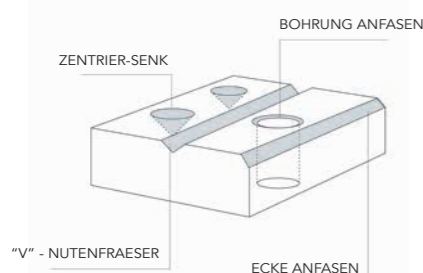

AUSSENBEARBEITUNG DREHALTER MIT INNENKÜHLUNG

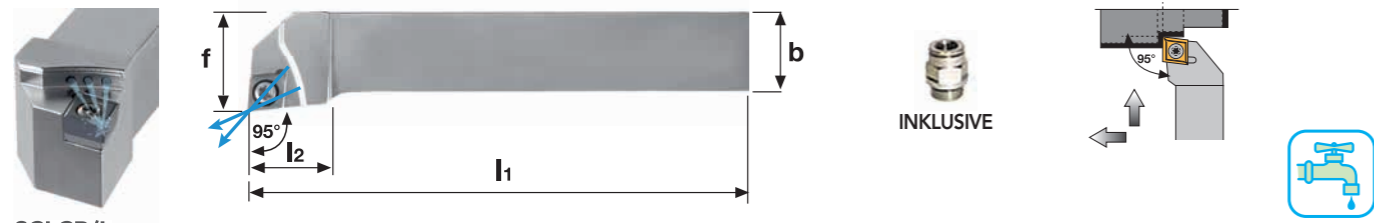

SCLCR/L Stahlschaft

Bestell-Nr.	Abmessungen (mm.)						Icons	STOCK	Aktionspreis € NET/STK.
	h1	h2	b	l1	l2	f			
SCLCR/L 1616 H09- IK G1/8	16	16	16	100	17	20	CCMT CCGT 09T3... US1111 GBS1111 SS1111	0,235	● 149,-
SCLCR/L 2020 K09- IK G1/8	20	20	20	125	17	25	CCMT CCGT 1204... US1221 GBS1221 SS1221	0,420	● 149,-
SCLCR/L 2525 M12- IK G1/8	25	25	25	150	20	32	CCMT CCGT 1204... US1221 GBS1221 SS1221	0,770	● 159,-

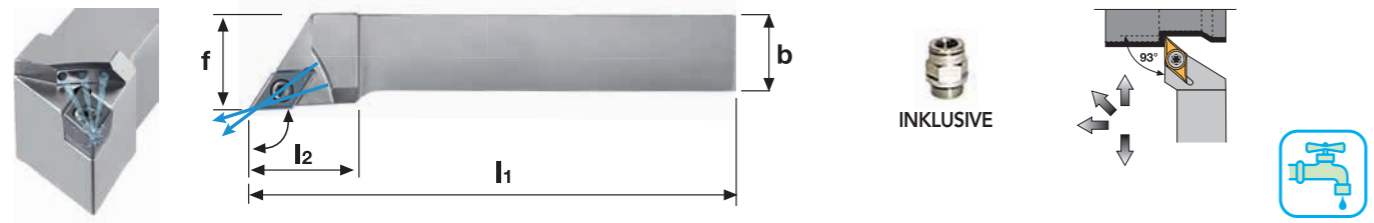

SDJCR/L Stahlschaft

Bestell-Nr.	Abmessungen (mm.)						Icons	STOCK	Aktionspreis € NET/STK.
	h1	h2	b	l1	l2	f			
SDJCR/L 1616 H11- IK G1/8	16	16	16	100	20	20	DCMT DCGT 11T3... US2311 GBS1111 SS1111	0,230	● 149,-
SDJCR/L 2020 K11- IK G1/8	20	20	20	125	24	25	DCMT DCGT 11T3... US2311 GBS1111 SS1111	0,408	● 149,-
SDJCR/L 2525 M11- IK G1/8	25	25	25	150	27	32	DCMT DCGT 11T3... US2311 GBS1111 SS1111	0,735	● 159,-

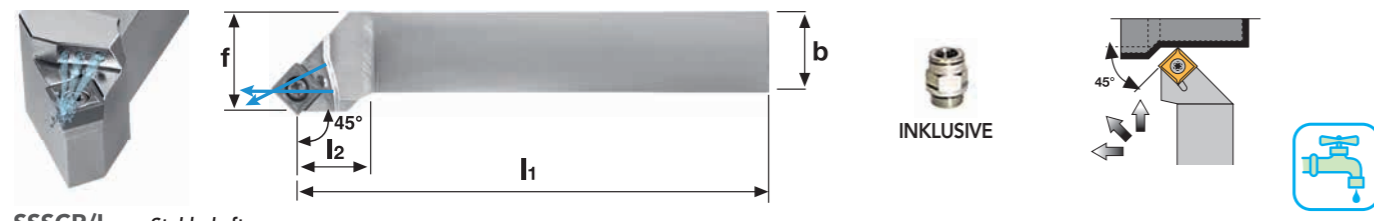

NEU SSSCR/L Stahlschaft

Bestell-Nr.	Abmessungen (mm.)						Icons	STOCK	Aktionspreis € NET/STK.
	h1	h2	b	l1	l2	f			
SSSCR/L 1616 H09- IK G1/8	16	16	16	100	20	20	SCMT SCGT 09T3... US4111 GBS1111 SS1111	0,235	● 149,-
SSSCR/L 2020 K09- IK G1/8	20	20	20	125	20	25	SCMT SCGT 1204... US4221 GBS1221 SS1221	0,420	● 149,-
SSSCR/L 2525 M12- IK G1/8	25	25	25	150	25	32	SCMT SCGT 1204... US4221 GBS1221 SS1221	0,770	● 159,-

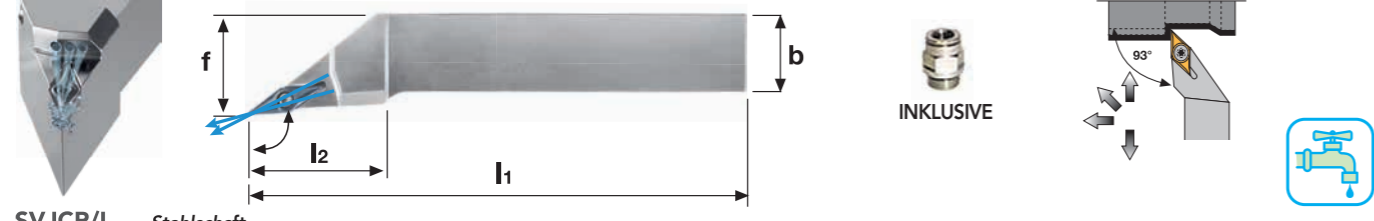

SVJCR/L Stahlschaft

Bestell-Nr.	Abmessungen (mm.)						Icons	STOCK	Aktionspreis € NET/STK.
	h1	h2	b	l1	l2	f			
SVJCR/L 1616 H11- IK G1/8	16	16	16	100	21,5	20	VCMT VCGT 1103... SS1751	0,203	● 149,-
SVJCR/L 2020 K11- IK G1/8	20	20	20	125	23	25	VCMT VCGT 1604... US6522 GBS1111 SS1111	0,373	● 149,-
SVJCR/L 2020 K16- IK G1/8	20	20	20	125	29,5	25	VCMT VCGT 1604... US6522 GBS1111 SS1111	0,380	● 149,-
SVJCR/L 2525 M16- IK G1/8	25	25	25	150	32,5	32	VCMT VCGT 1604... US6522 GBS1111 SS1111	0,677	● 159,-

AUSSENBEARBEITUNG DREHALTER MIT INNENKÜHLUNG

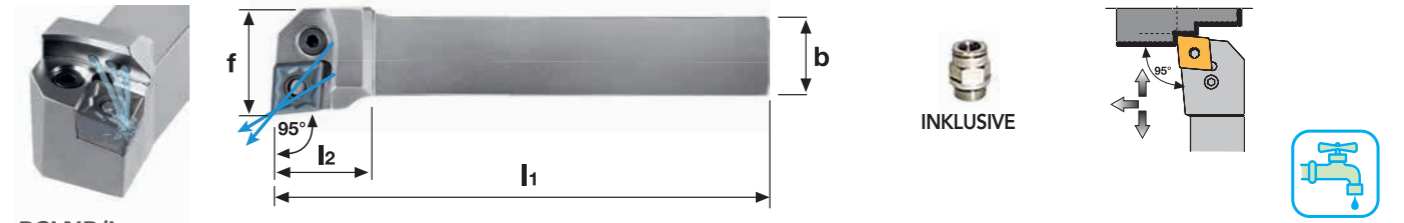

PCLNR/L Stahlschaft

Bestell-Nr.	Abmessungen (mm.)						Icons	STOCK	Aktionspreis € NET/STK.
	h1	h2	b	l1	l2	f			
PCLNR/L 1616 H12- IK G1/8	16	16	16	100	26,1	20	CNMG 1204... UP1111 HP 1111 SP 1111 RP 1111 MP 1111	0,254	● 149,-
PCLNR/L 2020 K12- IK G1/8	20	20	20	125	27,4	25	CNMG 1204... UP1111 HP 1111 SP 1111 RP 1111 MP 1111	0,428	● 149,-
PCLNR/L 2525 M12- IK G1/8	25	25	25	150	28	32	CNMG 1204... UP1111 HP 1111 SP 1111 RP 1111 MP 1111	0,751	● 159,-

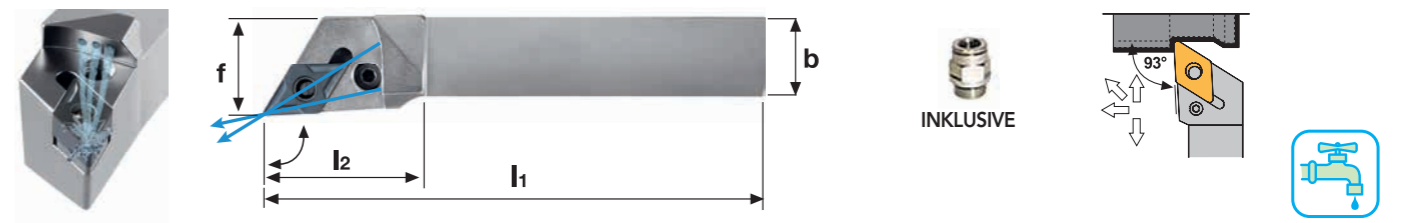

PDJNR/L Stahlschaft

Bestell-Nr.	Abmessungen (mm.)						Icons	STOCK	Aktionspreis € NET/STK.
	h1	h2	b	l1	l2	f			
PDJNR/L 1616 H11- IK G1/8	16	16	16	100	30	20	DNMG 1104... UP2011 HP2011 SP3111 RP3112 MP3111	0,220	● 149,-
PDJNR/L 2020 K15- IK G1/8	20	20	20	125	30	25	DNMG 1506... UP2421 HP2421 SP1111 RP1111 MP1111	0,411	● 149,-
PDJNR/L 2525 M15- IK G1/8	25	25	25	150	30	32	DNMG 1506... UP2421 HP2421 SP1111 RP1111 MP1111	0,737	● 159,-

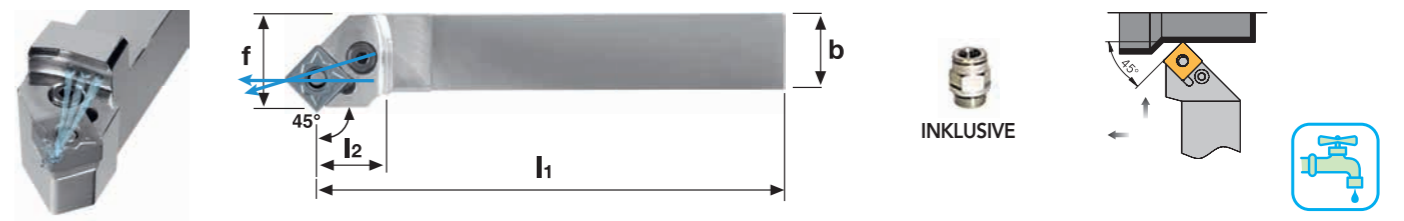

NEU PSSNR/L Stahlschaft

Bestell-Nr.	Abmessungen (mm.)						Icons	STOCK	Aktionspreis € NET/STK.
	h1	h2	b	l1	l2	f			
PSSNR/L 2020 K12- IK G1/8	20	20	20	125	29,4	25	SNMG1204... UP5112 HP1111 SP1111 RP1111 MP1111	0,430	● 149,-
PSSNR/L 2525 M12- IK G1/8	25	25	25	150	29,3	32	SNMG1204... UP5112 HP1111 SP1111 RP1111 MP1111	0,760	● 159,-

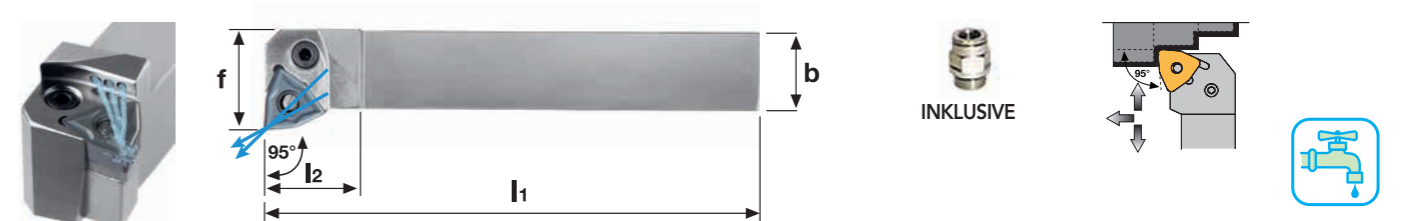

PWNLR/L Stahlschaft

Bestell-Nr.	Abmessungen (mm.)						Icons	STOCK	Aktionspreis € NET/STK.
	h1	h2	b	l1	l2	f			
PWNLR/L 2020 K08- IK G1/8	20	20	20	125	25	25	WNMG0804... UP71011 HP1111 SP 1111 RP1111 MP1111	0,420	● 149,-
PWNLR/L 2525 M08- IK G1/8	25	25	25	150	25	32	WNMG0804... UP71011 HP1111 SP 1111 RP1111 MP1111	0,767	● 159,-



INKLUSIV IN VERPACKUNG :
Adapter mit Anschlussgewinde G1/8"
Für Schlauch Durchmesser 8 mm



VHM BOHRSTANGEN-SÄTZE

SET E SCLCR/L 06

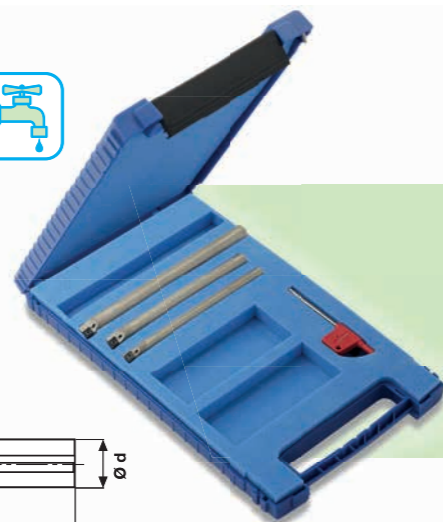

PROFIBOX

Träger

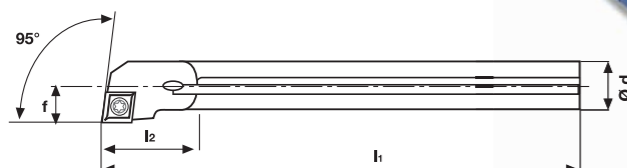

d	l ₁	l ₂	f	D _{min}
4	90	10	2,5	5
5	100	10	3	6
6	110	10	3,5	7
8	125	10	5	10
10	125	10	6	12
12	150	10	8	14
16	200	16	10	18
20	250	16	12	23
25	250	16	15	30
32	350	26	22	39

SET E SCLCR/L 06

Aktionspreis
€ 289,-
NET/SET

1PCS E08K SCLCR/L 06
1PCS E10K SCLCR/L 06
1PCS E12M SCLCR/L 06

HSS BOHRSTANGEN-SÄTZE

SET AH SCLCR/L 06



PROFIBOX

Träger

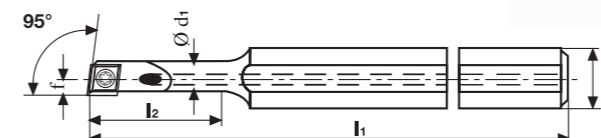

d	d ₁	l ₁	l ₂	f	D _{min}
8	6	100	25	4	8,5
10	8	110	32	6	12
12	10	125	38	7	14
16	12	150	50	9	18

SET AH SCLCR/L 06

Aktionspreis
€ 269,-
NET/SET

1PCS AH0608H SCLCR/L 06
1PCS AH0810J SCLCR/L 06
1PCS AH1012K SCLCR/L 06
1PCS AH1216M SCLCR/L 06

SET E SDUCR/L 07



PROFIBOX

Träger

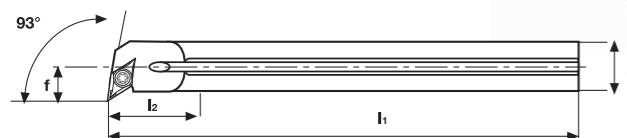

d	l ₁	l ₂	f	D _{min}
8	125	10	7,5	12,5
10	125	10	7	13
12	150	12,5	9	16
16	200	16,5	11	20
20	250	20,5	12,5	25
25	250	26	16	32

SET E SDUCR/L 07

Aktionspreis
€ 239,-
NET/SET

1PCS E10K SDUCR/L 07
1PCS E12M SDUCR/L 07

SET AH SDUCR/L 07



PROFIBOX

Träger

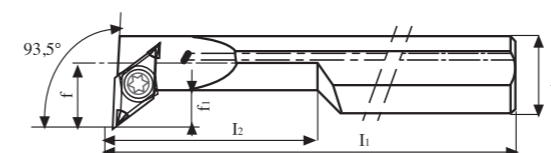

d	l ₁	l ₂	f	f ₁	D _{min}
10	100	22	7	5	12,5
12	125	28	9	5	15,5
16	150	36	11	5	19,5

SET AH SDUCR/L 07

Aktionspreis
€ 239,-
NET/SET

1PCS AH0810H SDUCR/L 07
1PCS AH1012K SDUCR/L 07
1PCS AH1216M SDUCR/L 07

STAHL BOHRSTANGEN-SÄTZE

SET A SCLCR/L 06



TRÄGER
STANDARDBOX

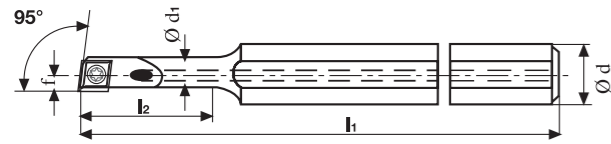

d	d ₁	l ₁	l ₂	f	D _{min}
8	6	100	21,5	4,2	8
10	8	110	27	6	11
12	10	125	32,5	7	13
16	12	150	42	9	16

SET A SCLCR/L 06

Aktionspreis	1PCS	A0608H	SCLCR/L 06
€ 149,- NET/SET	1PCS	A0810J	SCLCR/L 06
	1PCS	A1012K	SCLCR/L 06
	1PCS	A1216M	SCLCR/L 06

SET A SDUCR/L 07



TRÄGER
STANDARDBOX

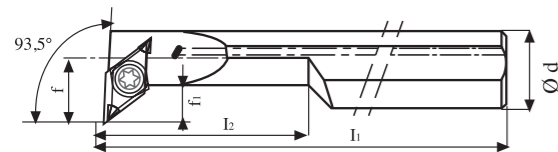

d	l ₁	l ₂	f	f ₁	D _{min}
10	100	22,5	6,5	4,4	12,5
12	125	27,5	9	5,9	15,5
16	150	40,5	11	4,9	18

SET A SDUCR/L 07

Aktionspreis	1PCS	A0810H	SDUCR/L 07
€ 149,- NET/SET	1PCS	A1012K	SDUCR/L 07
	1PCS	A1216M	SDUCR/L 07

VHM SCHAFTFRÄSER SETS

NEU SET MPE/MSE 25



PROFIBOX
VHM
Schaftfräser

25 VHM Schaftfräser
3- Schneidig 45°
4- Schneidig 35°

SET MPE 3T/25 TISIN 45°

Aktionspreis	05PCS	MPE0103 TISIN	SINGLE € 9,00 NET/PC
€ 149,- NET/SET	05PCS	MPE0153 TISIN	SINGLE € 9,00 NET/PC
	05PCS	MPE0203 TISIN	SINGLE € 9,00 NET/PC
	05PCS	MPE0303 TISIN	SINGLE € 9,00 NET/PC
	05PCS	MPE0403 TISIN	SINGLE € 9,00 NET/PC

SET MSE 4T/25 TISIN 35°

Aktionspreis	05PCS	MSE0104 TISIN	SINGLE € 9,00 NET/PC
€ 149,- NET/SET	05PCS	MSE0154 TISIN	SINGLE € 9,00 NET/PC
	05PCS	MSE0204 TISIN	SINGLE € 9,00 NET/PC
	05PCS	MSE0304 TISIN	SINGLE € 9,00 NET/PC
	05PCS	MSE0404 TISIN	SINGLE € 9,00 NET/PC

SET MPE/MSE 50



PROFIBOX
VHM
Schaftfräser

50 VHM Schaftfräser
3- Schneidig 45°
4- Schneidig 35°

SET MPE 3T TISIN 45°

Aktionspreis	10PCS	MPE0103 TISIN	SINGLE € 9,00 NET/PC
€ 289,- NET/SET	10PCS	MPE0153 TISIN	SINGLE € 9,00 NET/PC
	10PCS	MPE0203 TISIN	SINGLE € 9,00 NET/PC
	10PCS	MPE0303 TISIN	SINGLE € 9,00 NET/PC
	10PCS	MPE0403 TISIN	SINGLE € 9,00 NET/PC

SET MSE 4T/50 TISIN 35°

Aktionspreis	10PCS	MSE0104 TISIN	SINGLE € 9,00 NET/PC
€ 289,- NET/SET	10PCS	MSE0154 TISIN	SINGLE € 9,00 NET/PC
	10PCS	MSE0204 TISIN	SINGLE € 9,00 NET/PC
	10PCS	MSE0304 TISIN	SINGLE € 9,00 NET/PC
	10PCS	MSE0404 TISIN	SINGLE € 9,00 NET/PC

NEU SET MSB 50



PROFIBOX
VHM
Schaftfräser

50 VHM Schaftfräser
2- Schneidig 35°

SET MSB 2T/50 TISIN 35°

Aktionspreis	10PCS	MSB0102 TISIN	SINGLE € 15,00 NET/PC
€ 379,- NET/SET	10PCS	MSB0152 TISIN	SINGLE € 15,00 NET/PC
	10PCS	MSB0202 TISIN	SINGLE € 15,00 NET/PC
	10PCS	MSB0302 TISIN	SINGLE € 15,00 NET/PC
	10PCS	MSB0402 TISIN	SINGLE € 15,00 NET/PC

VHM SCHAFTFRÄSER SETS

SET NPE TISIN

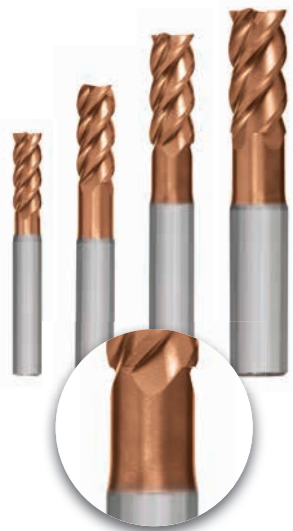

ZYLINDRISCH



PROFIBOX VHM Schaftfräser

4 VHM Schaftfräser
3-/4- Schneidig 45°

SET NPE 3T TISIN 45°

Aktionspreis	01PC	NPE0603 TISIN	SINGLE € 12,00	NET/PC
€ 89,-	01PC	NPE0803 TISIN	SINGLE € 23,00	NET/PC
NET/SET	01PC	NPE1003 TISIN	SINGLE € 34,00	NET/PC
	01PC	NPE1203 TISIN	SINGLE € 46,00	NET/PC

SET NPE 4T TISIN 45°

Aktionspreis	01PC	NPE0604 TISIN	SINGLE € 12,00	NET/PC
€ 89,-	01PC	NPE0804 TISIN	SINGLE € 23,00	NET/PC
NET/SET	01PC	NPE1004 TISIN	SINGLE € 34,00	NET/PC
	01PC	NPE1204 TISIN	SINGLE € 46,00	NET/PC

SET PE TISIN



ZYLINDRISCH



PROFIBOX VHM Schaftfräser

4 VHM Schaftfräser
3-/4- Schneidig 45°

SET PE 3T TISIN 45°

Aktionspreis	01PC	PE0603 TISIN	SINGLE € 12,00	NET/PC
€ 89,-	01PC	PE0803 TISIN	SINGLE € 23,00	NET/PC
NET/SET	01PC	PE1003 TISIN	SINGLE € 34,00	NET/PC
	01PC	PE1203 TISIN	SINGLE € 46,00	NET/PC

SET PE 4T TISIN 45°

Aktionspreis	01PC	PE0604 TISIN	SINGLE € 12,00	NET/PC
€ 89,-	01PC	PE0804 TISIN	SINGLE € 23,00	NET/PC
NET/SET	01PC	PE1004 TISIN	SINGLE € 34,00	NET/PC
	01PC	PE1204 TISIN	SINGLE € 46,00	NET/PC

NEU SET PE 16 TISIN



ZYLINDRISCH



PROFIBOX VHM Schaftfräser

5 VHM Schaftfräser
3-/4- Schneidig 45°

SET PE 3T 16 TISIN 45°

Aktionspreis	01PC	PE0603 TISIN	SINGLE € 12,00	NET/PC
€ 169,-	01PC	PE0803 TISIN	SINGLE € 23,00	NET/PC
NET/SET	01PC	PE1003 TISIN	SINGLE € 34,00	NET/PC
	01PC	PE1203 TISIN	SINGLE € 46,00	NET/PC
	01PC	PE1603 TISIN	SINGLE € 99,00	NET/PC

SET PE 4T 16 TISIN 45°

Aktionspreis	01PC	PE0604 TISIN	SINGLE € 12,00	NET/PC
€ 169,-	01PC	PE0804 TISIN	SINGLE € 23,00	NET/PC
NET/SET	01PC	PE1004 TISIN	SINGLE € 34,00	NET/PC
	01PC	PE1204 TISIN	SINGLE € 46,00	NET/PC
	01PC	PE1604 TISIN	SINGLE € 99,00	NET/PC

VHM SCHAFTFRÄSER SETS

NEU SET DH 4T TISIN

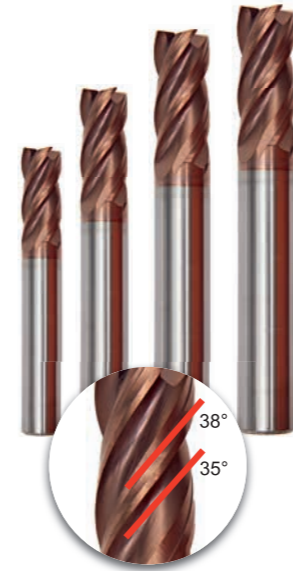

ZYLINDRISCH



PROFIBOX VHM Schaftfräser

4 VHM Schaftfräser
4- Schneidig 35° - 38°

SET DH 4T TISIN 35°/38°

Aktionspreis	01PC	DH0604 TISIN	SINGLE € 12,00	NET/PC
€ 89,-	01PC	DH0804 TISIN	SINGLE € 23,00	NET/PC
NET/SET	01PC	DH1004 TISIN	SINGLE € 34,00	NET/PC
	01PC	DH1204 TISIN	SINGLE € 46,00	NET/PC

NEU SET DH W 4T TISIN



WELDON



PROFIBOX VHM Schaftfräser

4 VHM Schaftfräser
4- Schneidig 35° - 38°

SET DH W 4T TISIN 35°/38°

Aktionspreis	01PC	DH0604 W TISIN	SINGLE € 12,00	NET/PC
€ 89,-	01PC	DH0804 W TISIN	SINGLE € 23,00	NET/PC
NET/SET	01PC	DH1004 W TISIN	SINGLE € 34,00	NET/PC
	01PC	DH1204 W TISIN	SINGLE € 46,00	NET/PC

HUFNAGEL

▶▶▶ die spanbrecher

Max Hufnagel GmbH
Brucker Straße 55
85221 Dachau

www.derhufnagel.de

**GERNE NEHMEN WIR IHRE
BESTELLUNG ENTGEGEN ...**

fon 0 81 31 / 6 15 41-0
fax 0 81 31 / 6 15 41-10
Email info@derhufnagel.de

WENN SIE FRAGEN HABEN, BITTE KONTAKTIEREN SIE UNS!
